

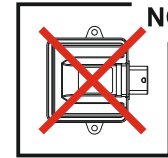

**CORRECT  
INSTALLATION**

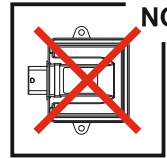
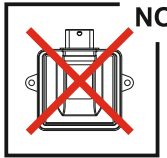
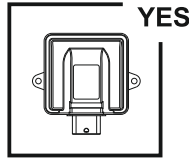

A1	INJ1_petrol_ECU	A2	INJ2_petrol_ECU	A3	INJ3_petrol_ECU	A4	INJ4_petrol_ECU
B1	INJ1_petrol	B2	INJ2_petrol	B3	INJ3_petrol	B4	INJ4_petrol
C1	INJ1_Gas	C2	INJ2_Gas	C3	INJ3_Gas	C4	INJ4_Gas
D1	Ignition switch signal (optional)	D2	Gas pressure	D3	MAP	D4	Lambda probe \ RPM
E1	Gas temperature sensor	E2	Reducer temperature sensor	E3	Gas level sensor	E4	Petrol-Gas switch date
F1	Petrol-Gas switch power supply	F2	Pressure sensor power supply	F3	RXD diagnostic connector	F4	TXD diagnostic connector
G1	+12 INJECTORS	G2	GND SIGNAL (out)	G3	+12 battery	G4	GND
H1	+12 INJECTORS	H2	+12 Electro-valve	H3	+12 battery	H4	GND

**ATTENTION: Connect only one of the options.**

**Option 1**

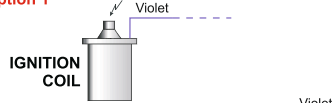

**Option 2**

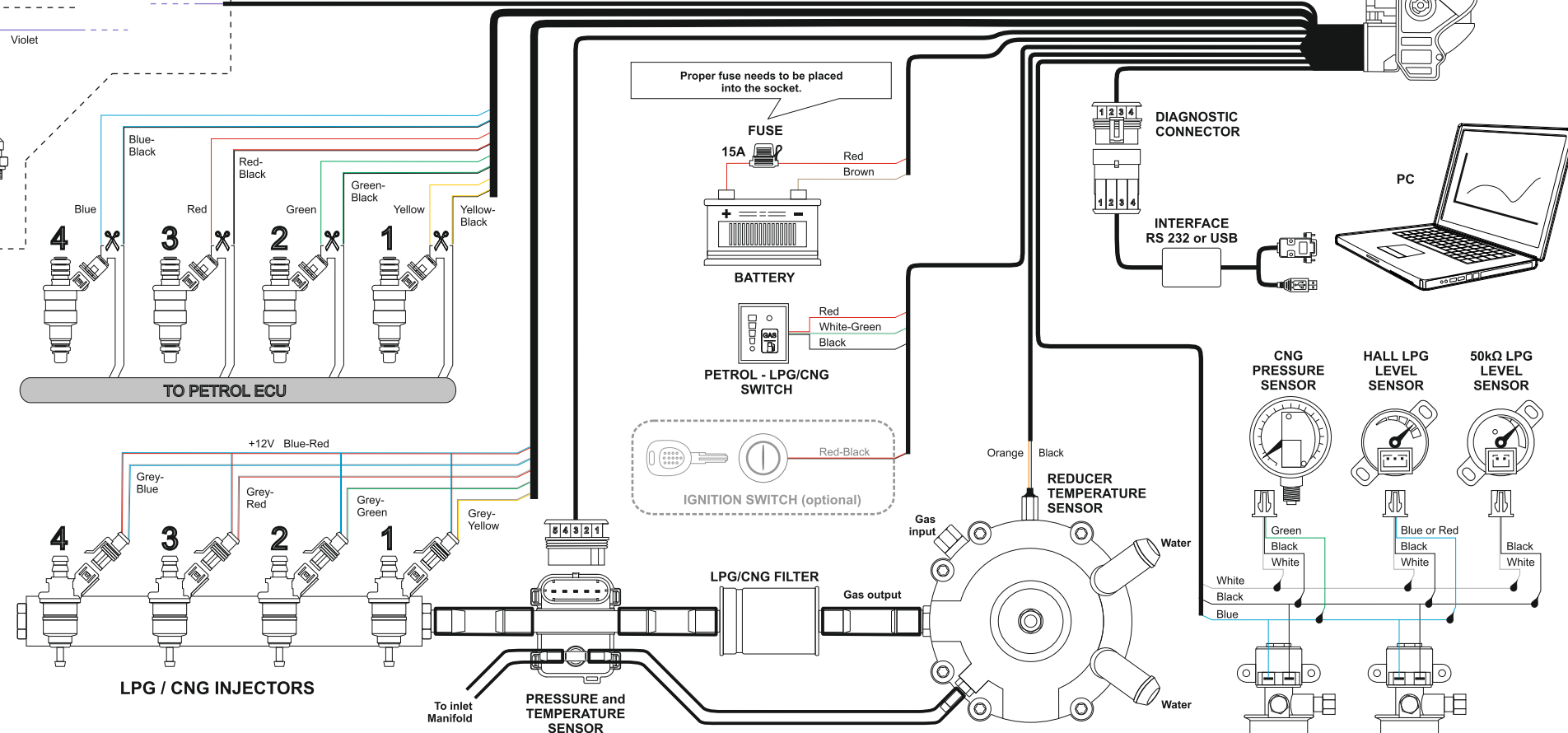
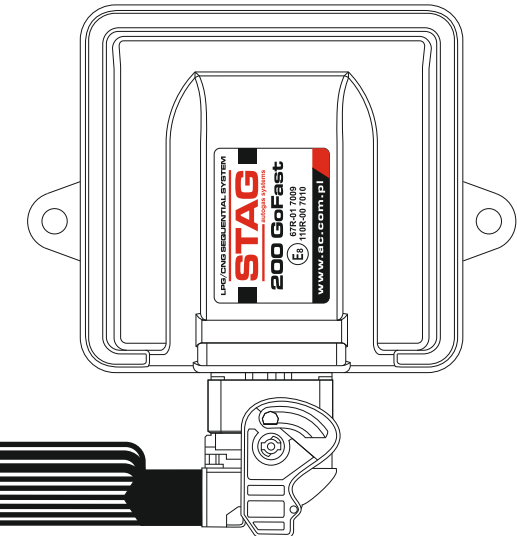
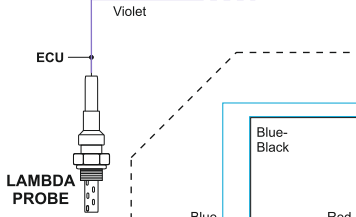

## STAG 200 GoFast

### Wiring diagram



Manufacturer:  
AC Spółka Akcyjna  
15-181 Białystok, ul. 42 Pułku Piechoty 50, Poland  
tel. +48 85 7438117, fax +48 85 6538649  
www.ac.com.pl, e-mail: autogaz@ac.com.pl

"04-128.95.00.10 z dn. 10.12.2018"

**ATTENTION: The current version of Stag200Easy application is available on website: [www.ac.com.pl/en/doc/346/instructions](http://www.ac.com.pl/en/doc/346/instructions)**

НАДЛЕЖАЩИЙ  
МОНТАЖ

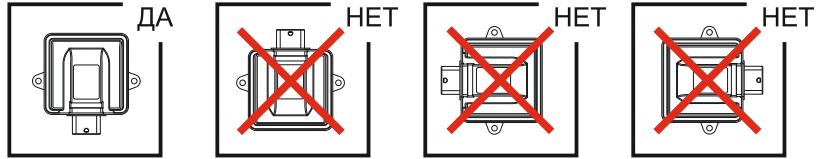

**ВНИМАНИЕ:** Подключить только один из вариантов.

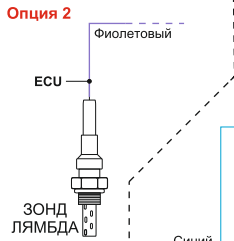

A1	Инжектор_1_бензина_ECU	A2	Инжектор_2_бензина_ECU	A3	Инжектор_3_бензина_ECU	A4	Инжектор_4_бензина_ECU
B1	Инжектор_1_бензина	B2	Инжектор_2_бензина	B3	Инжектор_3_бензина	B4	Инжектор_4_бензина
C1	Инжектор_1_Газ	C2	Инжектор_2_Газ	C3	Инжектор_3_Газ	C4	Инжектор_4_Газ
D1	Сигнал замка зажигания	D2	Давление Газ	D3	Вакуумметрическое давление	D4	Лямбда-зонд \ RPM
E1	Температура Газ	E2	Температура редуктора	E3	Уровень Газ	E4	Светодиодная панель данные
F1	Питание светодиодной панели	F2	Питание датчика давления	F3	RXD диагностические разъёмы	F4	TXD диагностические разъёмы
G1	+12 Форсунки	G2	Заземление «земля» (выход)	G3	+12 Аккумулятор	G4	Заземление
H1	+12 Форсунки	H2	+12 Клапан Газ	H3	+12 Аккумулятор	H4	Заземление

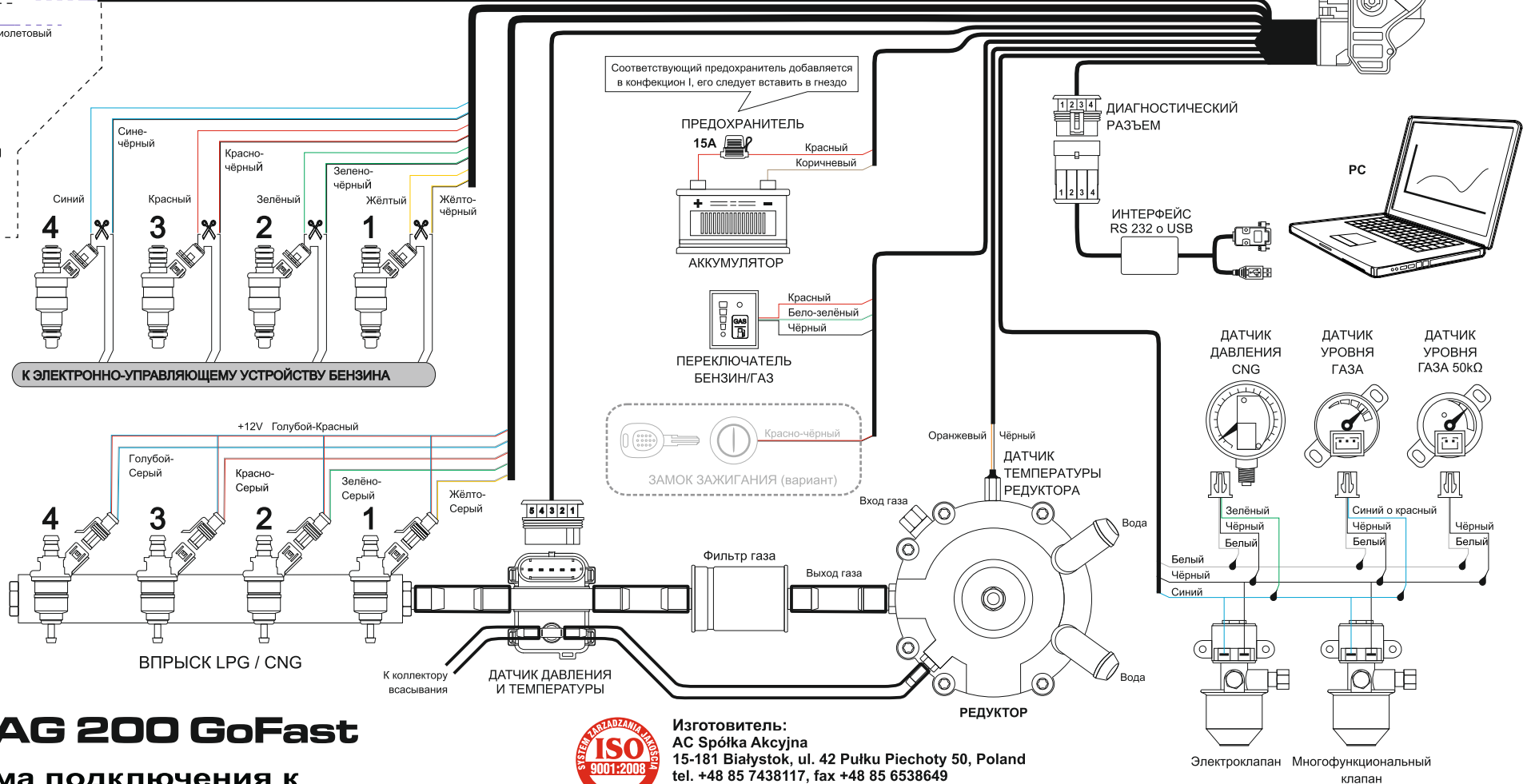
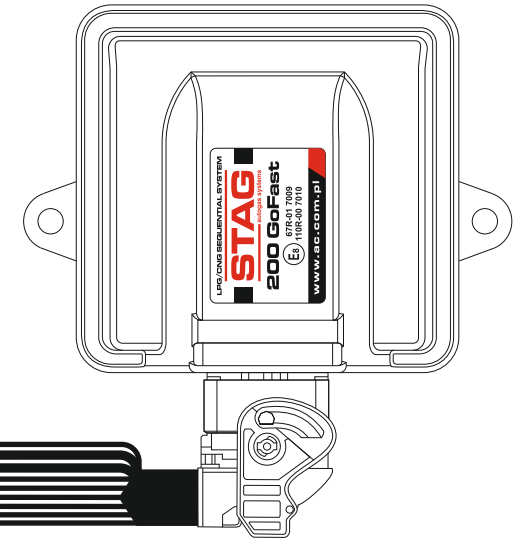

## STAG 200 GoFast

Схема подключения к автомобильной установке



Изготовитель:  
AC Spółka Akcyjna  
15-181 Białystok, ul. 42 Pułku Piechoty 50, Poland  
tel. +48 85 7438117, fax +48 85 6538649  
www.ac.com.pl, e-mail: autogaz@ac.com.pl  
\*04-128.95.00.10 z dn. 10.12.2018\*

ВНИМАНИЕ: Актуальная версия программы Stag200Easy доступна на интернет сайте: [www.ac.com.pl/ru/doc/346/instrukcii-po-obsuzhivaniyu](http://www.ac.com.pl/ru/doc/346/instrukcii-po-obsuzhivaniyu)

## MONTAJE CORRECTO DEL CONTROLADOR

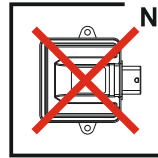
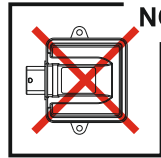
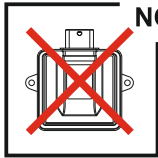
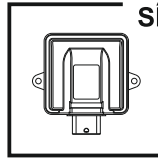

¡ATENCIÓN! Conectar sólo una de las opciones.

Opción 1

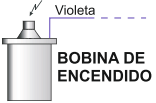

Opción 2

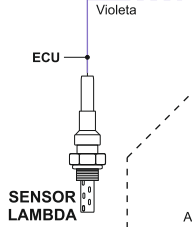

A1	inyector de gasolina 1 ECU	A2	inyector de gasolina 2 ECU	A3	inyector de gasolina 3 ECU	A4	inyector de gasolina 4 ECU
B1	inyector de gasolina 1	B2	inyector de gasolina 2	B3	inyector de gasolina 3	B4	inyector de gasolina 4
C1	inyector de gas 1	C2	inyector de gas 2	C3	inyector de gas 3	C4	inyector de gas 4
D1	Señal interruptor del encendido (opcional)	D2	Presión de gas	D3	Mapa de señal	D4	Sensor Lambda \ RPM
E1	Temperatura de gas	E2	Temperatura de reductor	E3	Nivel de gas	E4	Conmutador LED datos
F1	Alimentación interruptor	F2	Alimentación sensor de presión	F3	RXD conector de diagnóstico	F4	TXD conector de diagnóstico
G1	+12V inyectores	G2	GND señal	G3	+12V batería	G4	GND
H1	+12V inyectores	H2	+12V electroválvula GLP/GNV	H3	+12V batería	H4	GND

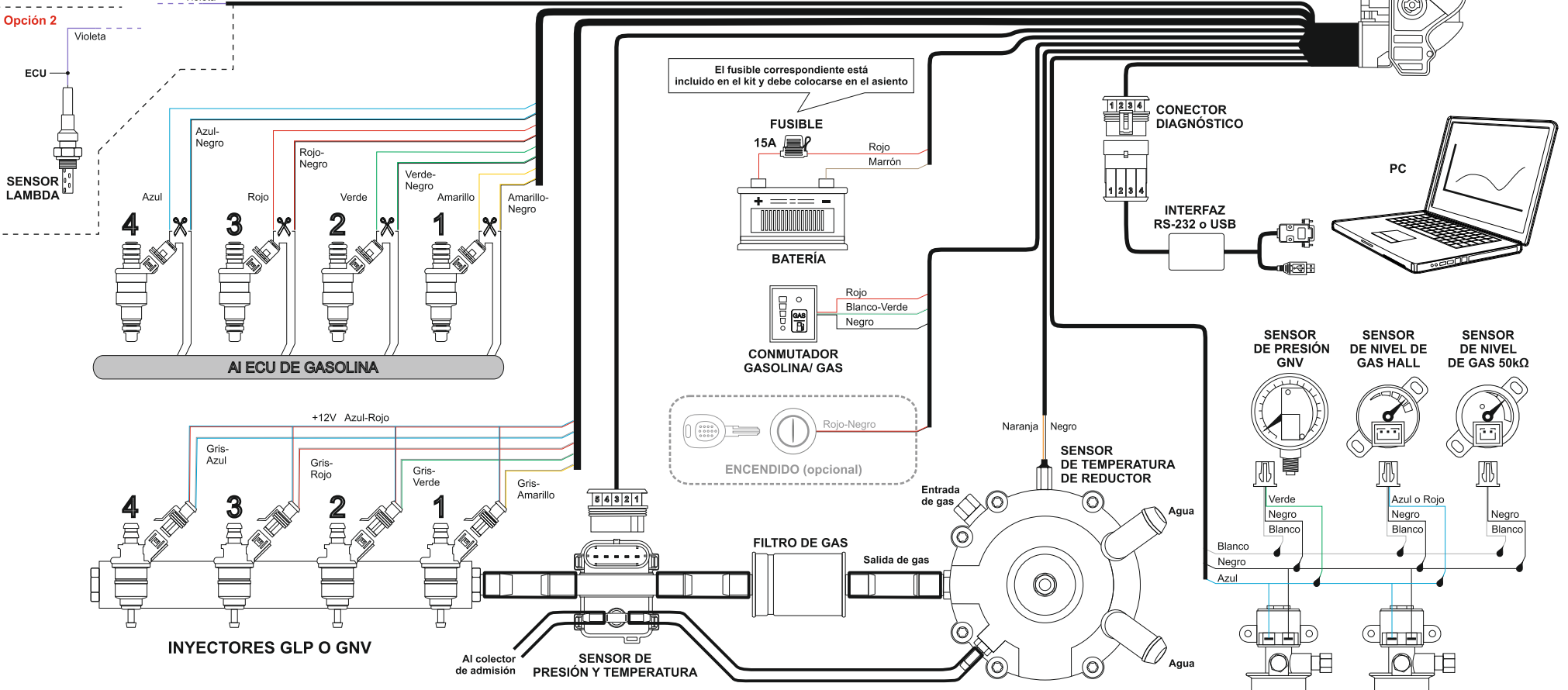
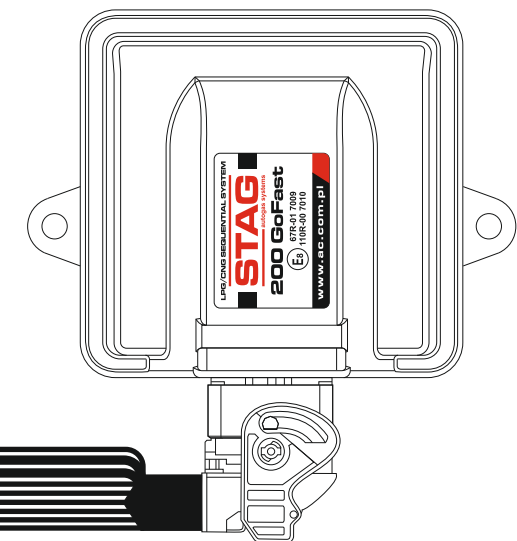

## STAG 200 GoFast

Esquema de conexión a la instalación del vehículo



Fabricante:  
AC Spółka Akcyjna  
15-181 Białystok, ul. 42 Pułku Piechoty 50, Poland  
tel. +48 85 7438117, fax +48 85 6538649  
www.ac.com.pl, e-mail: autogaz@ac.com.pl  
\*04-128.95.00.10 z dn. 10.12.2018\*

¡ATENCIÓN! La versión actual de la aplicación STAG200Easy está disponible en la página web: [www.ac.com.pl/es/doc/346/instrucciones-de-uso](http://www.ac.com.pl/es/doc/346/instrucciones-de-uso)

## INSTALLATION CORRECTE

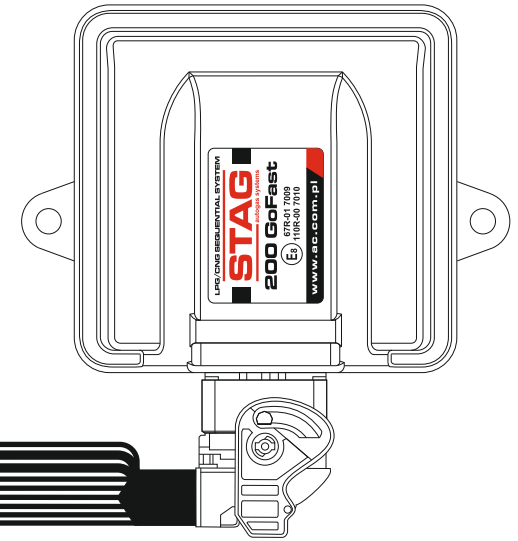
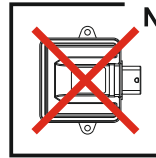
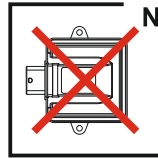
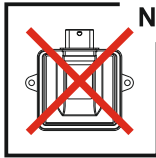
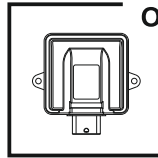

A1	INJ1_essence_ECU	A2	INJ2_essence_ECU	A3	INJ3_essence_ECU	A4	INJ4_essence_ECU
B1	INJ1_essence	B2	INJ2_essence	B3	INJ3_essence	B4	INJ4_essence
C1	INJ1_Gaz	C2	INJ2_Gaz	C3	INJ3_Gaz	C4	INJ4_Gaz
D1	Signal d'allumage (optionnel)	D2	Pression GPL	D3	Dépression	D4	Sonde Lambda / RPM
E1	Temperature GPL	E2	Temperature de vaporisateur	E3	Niveau gaz	E4	Commutateur led données
F1	Alimentation de commutateur	F2	Alimentation de capteur de pression	F3	RXD connecteur de diagnostic	F4	TXD connecteur de diagnostic
G1	+12 injecteurs	G2	GND signal (sortie)	G3	+12 batterie	G4	GND
H1	+12 injecteurs	H2	+12 Valve de gaz	H3	+12 batterie	H4	GND

ATTENTION: Relier juste une option.

Option 1

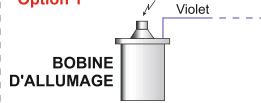

Option 2

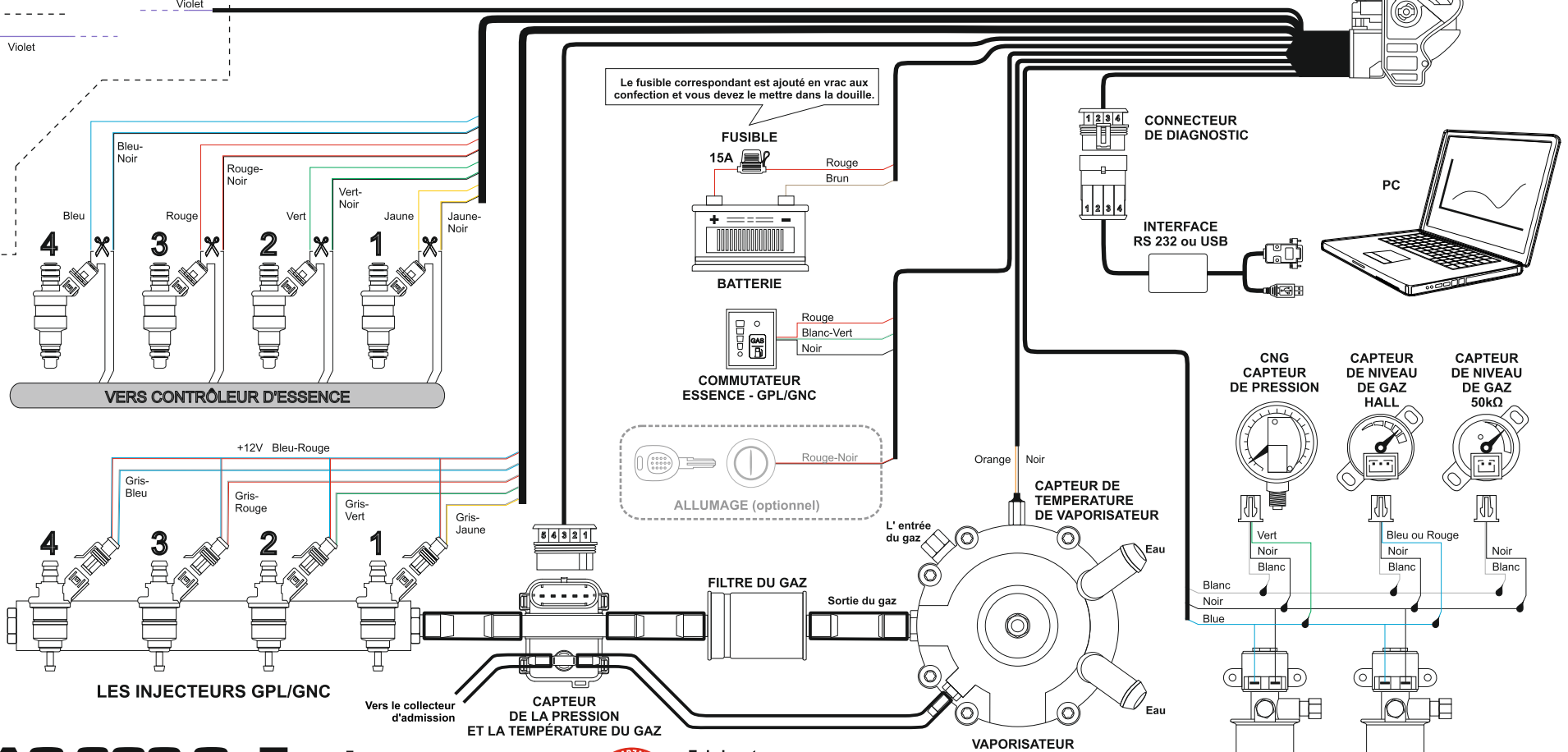
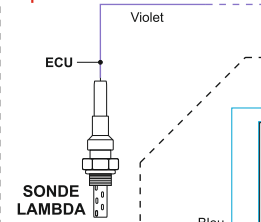

## STAG 200 GoFast

Schéma pour le raccordement à la voiture



Fabricant:  
AC Spółka Akcyjna  
15-181 Białystok, ul. 42 Pułku Piechoty 50, Poland  
tel. +48 85 7438117, fax +48 85 6538649  
www.ac.com.pl, e-mail: autogaz@ac.com.pl

\*04-128.95.00.10 z dn. 10.12.2018\*

MONTAGGIO  
CORRETTO

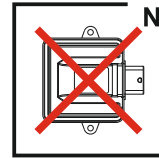
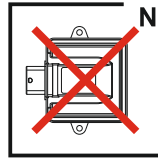
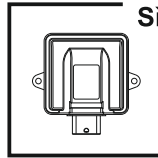

ATTENZIONE: Collega  
solo una delle opzioni.

Opzione 1

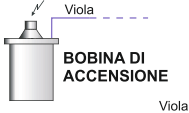

Opzione 2

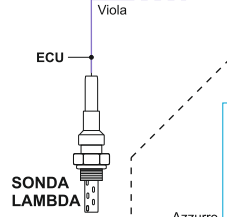

A1	Iniett1_centralina_benzina	A2	Iniett2_centralina_benzina	A3	Iniett3_centralina_benzina	A4	Iniett4_centralina_benzina
B1	Iniett1_benzina	B2	Iniett2_benzina	B3	Iniett3_benzina	B4	Iniett4_benzina
C1	Iniett1_gas	C2	Iniett2_gas	C3	Iniett3_gas	C4	Iniett4_gas
D1	Segnale accensione commutatore (opzionale)	D2	Pressione gas	D3	MAP	D4	Sonda lambda / RPM
E1	Sensore temperatura gas	E2	Sensore temperatura riduttore	E3	Sensore livello gas	E4	Data commutatore benzina-gas
F1	Alimentazione commutatore benzina-gas	F2	Alimentazione sensore di pressione	F3	RXD connettore diagnostico	F4	TXD connettore diagnostico
G1	+12 iniettori	G2	Segnale GND (out)	G3	+12 batteria	G4	GND
H1	+12 iniettori	H2	+12 elettrovalvola	H3	+12 batteria	H4	GND

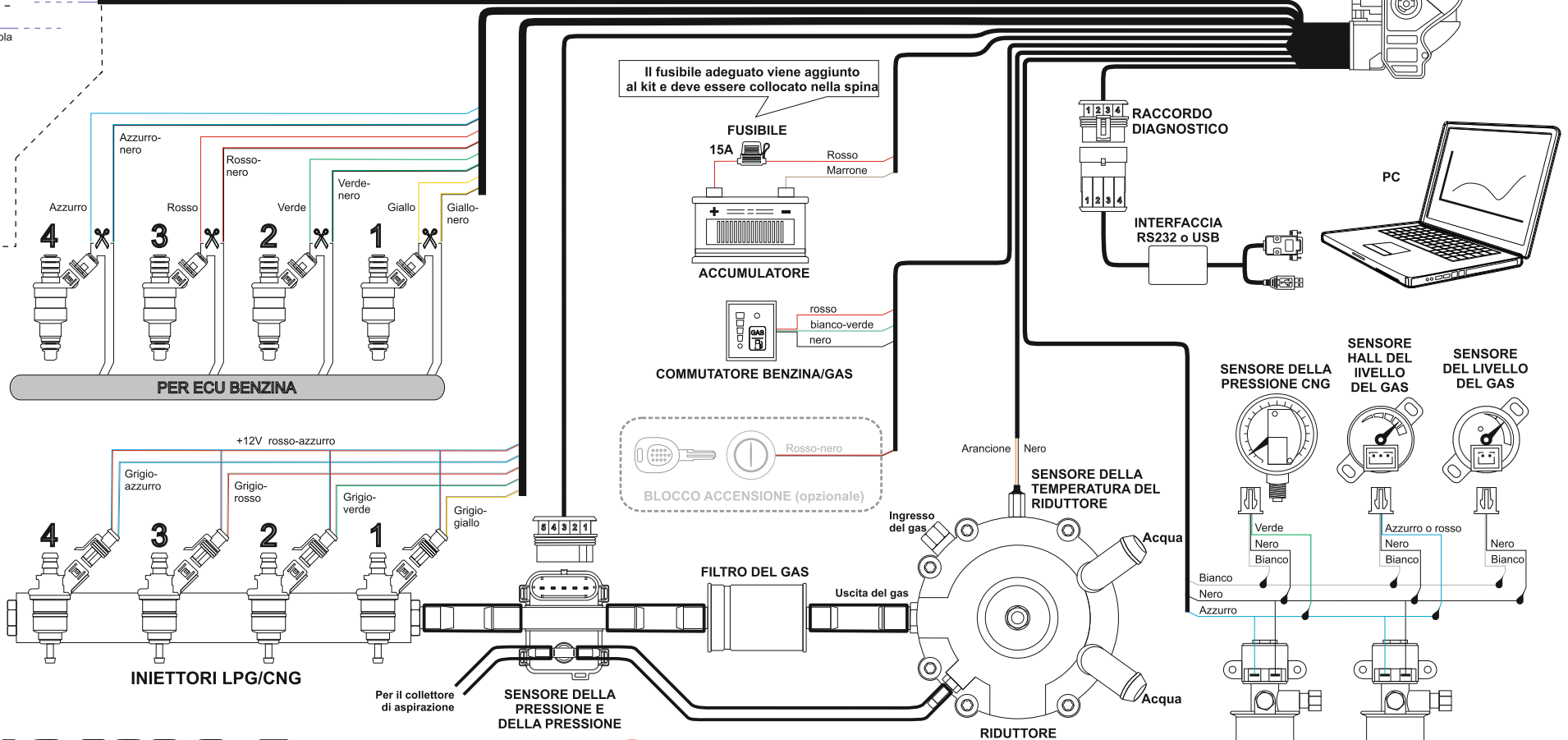
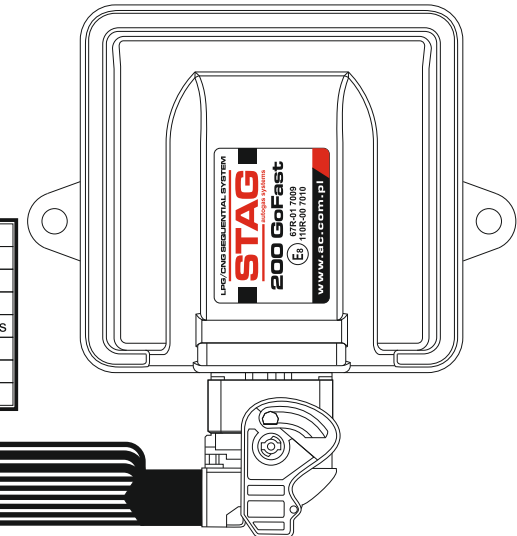

## STAG 200 GoFast

Schema di collegamento della centralina  
STAG 200 GoFast all'impianto dell'auto



Produttore:  
AC Spółka Akcyjna  
15-181 Białystok, ul. 42 Pułku Piechoty 50, Poland  
tel. +48 85 7438117, fax +48 85 6538649  
www.ac.com.pl, e-mail: autogaz@ac.com.pl  
\*04-128.95.00.10 z dn. 10.12.2018\*

## A INSTALAÇÃO CORRETA DO DRIVER

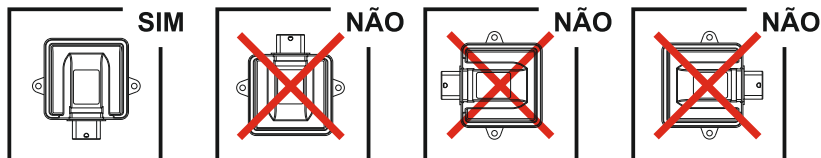

A1	Injetor de gasolina 1 ECU	A2	Injetor de gasolina 2 ECU	A3	Injetor de gasolina 3 ECU	A4	Injetor de gasolina 4 ECU
B1	Injetor de gasolina 1	B2	Injetor de gasolina 2	B3	Injetor de gasolina 3	B4	Injetor de gasolina 4
C1	Injetor de gas 1	C2	Injetor de gas 2	C3	Injetor de gas 3	C4	Injetor de gas 4
D1	Signal de ignição (opcional)	D2	Pressão de gás	D3	Underpressure	D4	Sensor Lambda / RPM
E1	Temperatura de gás	E2	Temperatura de redutor	E3	Nível Gás	E4	Interruptor LED dados
F1	Interruptor de alimentação LED	F2	Alimentação sensor de pressão	F3	RXD Conetor de diagnóstico	F4	TXD Conetor de diagnóstico
G1	+12 Injetores	G2	GND Massa(saída)	G3	+12 bateria	G4	GND
H1	+12 Injetores	H2	+12 electroválvula Gás	H3	+12 bateria	H4	GND

**ATENÇÃO:**  
Conecte apenas uma das opções.

Opção 1



Opção 2

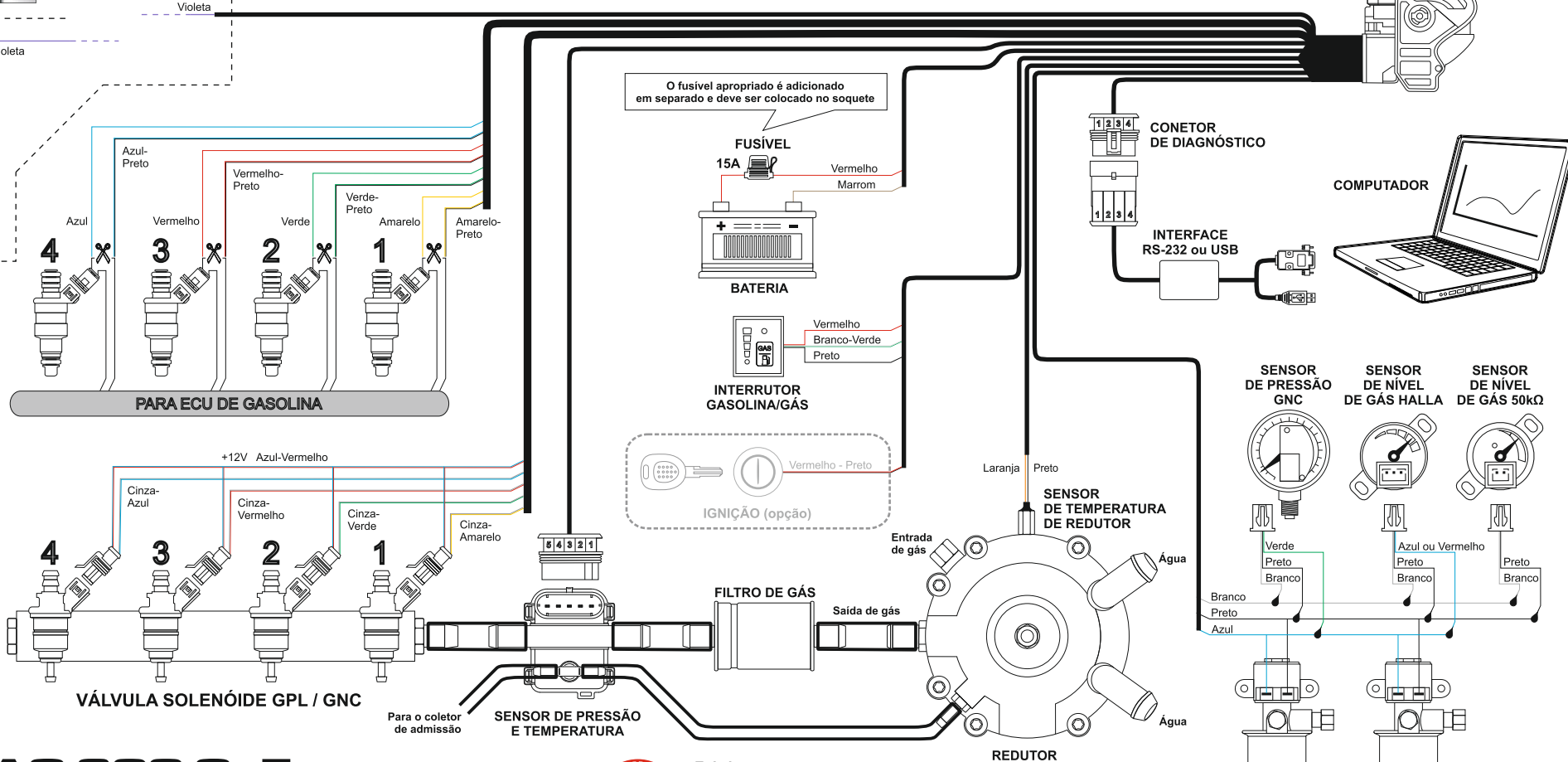
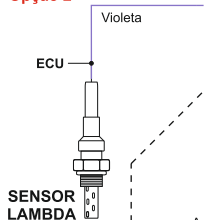

# STAG 200 GoFast

Diagrama de fiação



Fabricante:  
AC Spółka Akcyjna  
15-181 Białystok, ul. 42 Pułku Piechoty 50, Poland  
tel. +48 85 7438117, fax +48 85 6538649  
www.ac.com.pl, e-mail: autogaz@ac.com.pl  
\*04-128.95.00.10 z dn. 10.12.2018\*

**ATENÇÃO:** A versão atual do aplicativo Stag200Easy está disponível no site: [www.ac.com.pl/pl/doc/346/instrukcje-obslugi](http://www.ac.com.pl/pl/doc/346/instrukcje-obslugi)